











TERMOCONTACTOS / TERMOVALVULAS





THERMOCONTACTS / THERMOVALVES





11



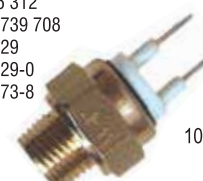

CAPITULO // CHAPTER





Aislante Negro	 22	7000
13 41 010		
		
70° - 65°		
TOYOTA (OPCIONAL COROLLA)		
 M 16 x 1,5	 6,35	





Aislante Blanco	 22	7001
13 41 010		
		
95° - 90°		
OPEL		
 M 14 x 1,5	 6,35	





Aislante Rojo	 22	7002
13 64 2 73 61 31 1 364 273		
		
102° - 97°		
BMW - OPEL		
 M 14 x 1,5	 6,35	





Aislante Blanco	 22	7003
92 045 312 77 00 739 708 1276229 1276229-0 3206773-8		
		
100° - 95°		
GENERAL MOTORS - RENAULT - VOLVO		
 M 14 x 1,5	 6,35	





Aislante Blanco	 21	7004
7588881		
		
75°		
FIAT - LANCIA		
 M 8 x 1,25 CILIND.	 6,35	





Aislante Negro	 21	7005
0269193693		
		
65° - 55°		
VOLKSWAGEN		
 M 10 x 1 CILIND.	 6,35	



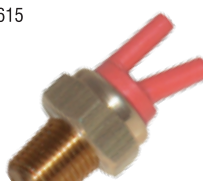

Aislante Blanco	 19	7006
7574407		
		
45°		
FIAT		
 M 10 x 1,25 CONICO		





Aislante Negro	 19	7007
7541872		
		
50°		
FIAT		
 M 10 x 1,25		





Aislante Azul	 19	7008
7574406		
		
65°		
FIAT		
 M 10 x 1,25		





Aislante Amarillo	 19	7009
4406143		
		
40°		
FIAT		
 M 10 x 1,25		





Aislante Rojo	 19	7010
5939615		
		
40°		
FIAT		
 M 16 x 1,5 CONICO		



Aislante Amarillo	 19	7011
7533294		
		
55°		
FIAT		
 M 16 x 1,5 CONICO		

Aislante Amarillo	 19	7012
026.131.851.1		
		
58°		
VOLKSWAGEN		
 M 10 x 1		

Aislante Negro	 19	7013
055.131.851.C		
		
60°		
VOLKSWAGEN		
 M 10 x 1		

Aislante Azul	 19	7014
056.131.851		
		
52°		
VOLKSWAGEN		
 M 10 x 1		

Aislante Negro	 19	7015
027.131.851		
		
46°		
VOLKSWAGEN		
 M 10 x 1		

Aislante Negro	 19	7016
058.131.851.A		
		
46°		
VOLKSWAGEN		
 M 10 x 1	